

Installation Survey Guide - Intu Roller



Flush or Recessed Rubber Bead



Measure clear glass width and drop

- Min Width: 325mm
- Max Width: 1400mm
- Max Drop: 2000mm subject to fabric choice
- Max Area: 2m²

Proud Rubber Bead

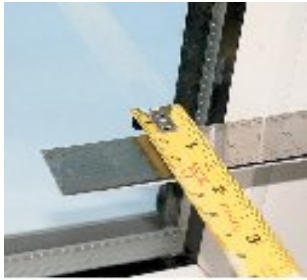

Max Bead Depth: 27mm

Min Bead Depth: 11mm

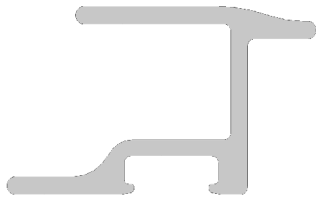

Side Extrusion: Standard

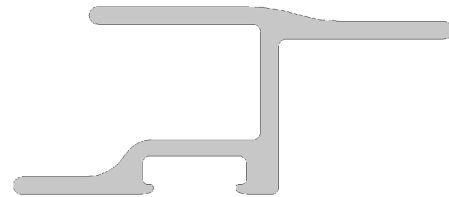

Side Extrusion: Large

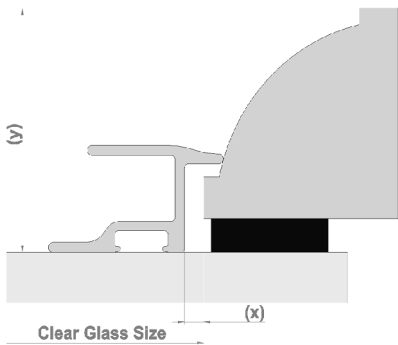

Select side extrusion that gives smallest gap between extrusion and window bead (x)

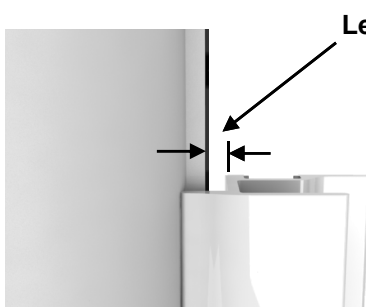
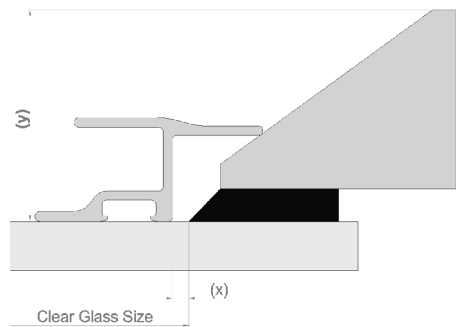

Less than 1mm

Where the gap is greater than 1mm. This size **MUST** BE deducted from clear glass size (Both sides!)

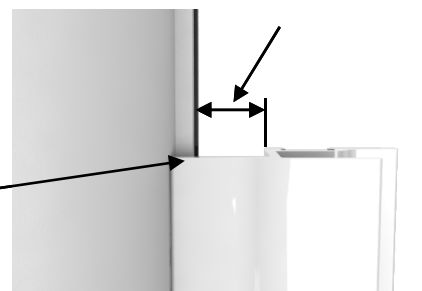

Greater than 1mm but Less than 7mm

A

B

C

D

E

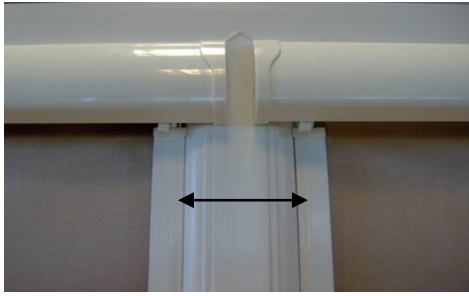

50mm Standard

Headrail Size

The Headrail overlap size is 25mm standard only. Ensuring no special instruction necessary.

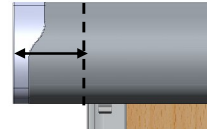

25mm Standard

F



Vent

Measure

Air Vents

When headrail may foul on air vents or other obstructions, a deduction of up to **10mm** can be made from the clear glass size(drop).

This can be measured by using a small section of headrail fascia fitted with a fixing bracket.

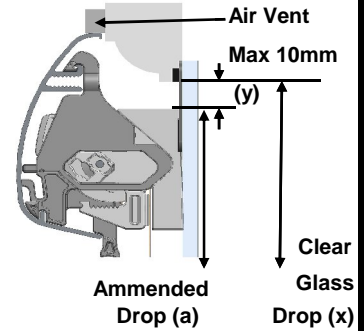

G

Enter drop (a) on order form (x - y = a)